

Exploring the Architectures of Network Analyzers

Application Note 1287-2

Table of Contents

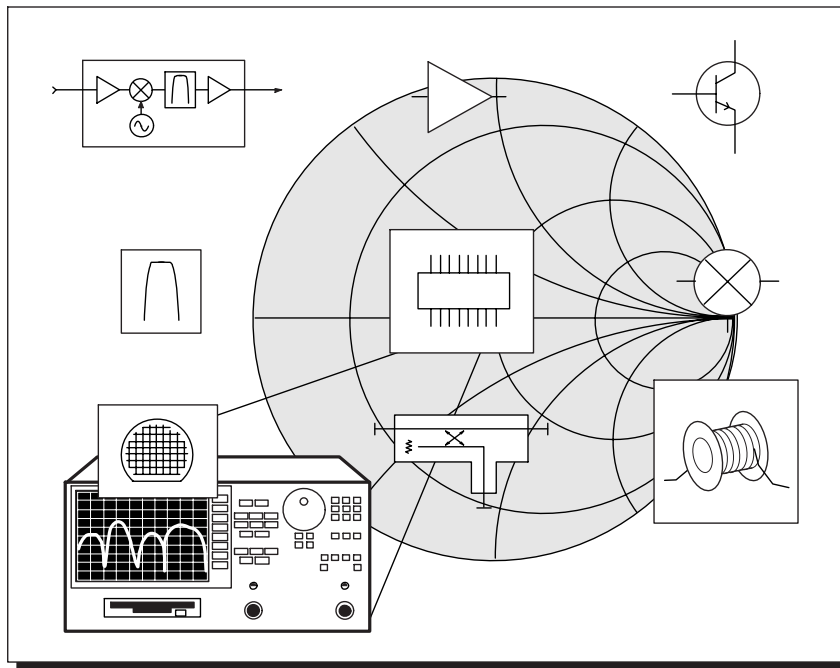

	Page
Introduction	2
Network Analyzer Architecture	2
Coupling Signals	3
Directional Bridges	6
Network Analyzer Detection	6
Comparing Dynamic Range	8
The Spectrum	
Analyzer Alternative	9
The Test Set	9
Other Considerations	10

Introduction

Network analyzers have become one of the most important measurement tools for characterizing the performance of high-frequency components and devices. A modern vector network analyzer can measure a component's magnitude, phase, and group delay, show port impedances on a Smith chart, and, with time-domain capability, show the distance from a test port to an impedance mismatch or circuit fault. Understanding a network analyzer's capabilities and operation can help an operator derive optimum performance from the instrument.

Hewlett-Packard Company offers an extensive line of RF and microwave network analyzers for applications from DC to 110 GHz. These analyzers are available with a variety of test sets and calibration kits and can be equipped with such options as time-domain capability for making distance-to-fault evaluations in transmission lines. The company also supplies linear and nonlinear computer-aided-engineering (CAE) software tools such as the HP EEsof Microwave Design System (MDS) and Series IV Suite, useful in creating device and component models based on vector network analyzer measurements.

Network Analyzer Architecture

Network analyzers differ in form and function from another tool commonly used to characterize communications systems and components, the spectrum analyzer (Figure 1). Spectrum analyzers measure unknown external signals. In contrast, network analyzers utilize synthesized-frequency sources to provide a known test stimulus that can sweep across a range of frequencies or power levels. Network analyzers also can perform ratioed measurements (including phase), which require multiple receivers. These measurements cannot be performed with a spectrum analyzer, even when it is complemented by a tracking generator.

Spectrum analyzers are generally employed to measure signal characteristics such as carrier level, sidebands, harmonics, and phase noise. They are usually configured as a single-channel receiver without a source. These instruments have a wide range of IF bandwidths available in order to analyze diverse types of signals and are often used with external sources for nonlinear stimulus/response testing. When combined with a tracking generator, spectrum analyzers can be used for scalar component testing to show magnitude versus frequency information but not phase information.

Figure 1.
Differences
between Network
and Spectrum
Analyzers

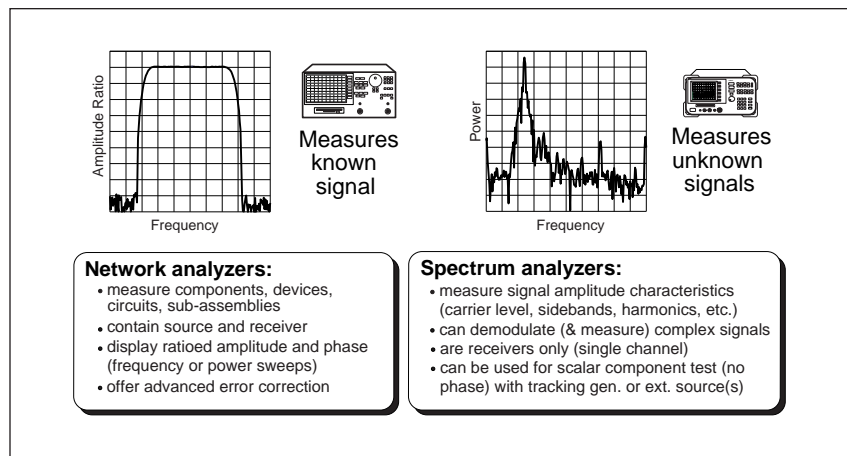

Network analyzers can provide a wealth of knowledge about a device under test (DUT), including its magnitude, phase, and group-delay response. To accomplish this, a network analyzer must provide a source for stimulus, signal-separation devices, receivers for signal detection, and display/processing circuitry for reviewing results (Figure 2). The source is usually a built-in phase-locked (synthesized) voltage-controlled oscillator.

Signal-separation hardware allows measurements of a portion of the incident signal to provide a reference for ratio measurements, and it separates the incident (forward) and reflected (reverse) signals present at the input of the DUT. Hardware for this purpose includes power dividers (which are resistive and broadband, but have high insertion loss), directional couplers (which have low loss but are usually limited in bandwidth), and directional bridges (which are useful for measuring reflected signals over a broad bandwidth, but may also have significant loss).

Figure 2.
Generalized
Network
Analyzer Block
Diagram

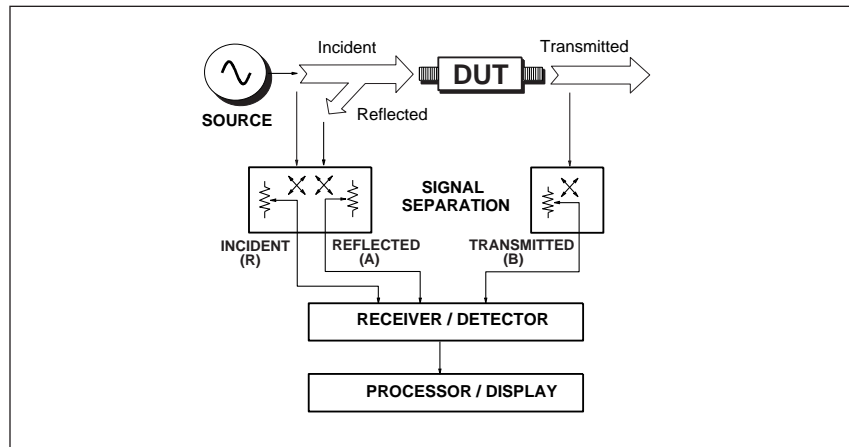

Coupling Signals

Directional couplers are useful for measuring both the incident and reflected signals present at the input of the DUT. Directional couplers consist of a “through” path, and a “coupled” path that diverts a small amount of the power traveling along the through path (Figure 3). The amount of coupled power is determined by the coupling factor:

$$\text{Coupling factor (in dB)} = -10 \log (\text{forward coupled power} / \text{incident power})$$

Figure 3.
Forward
Coupling Factor

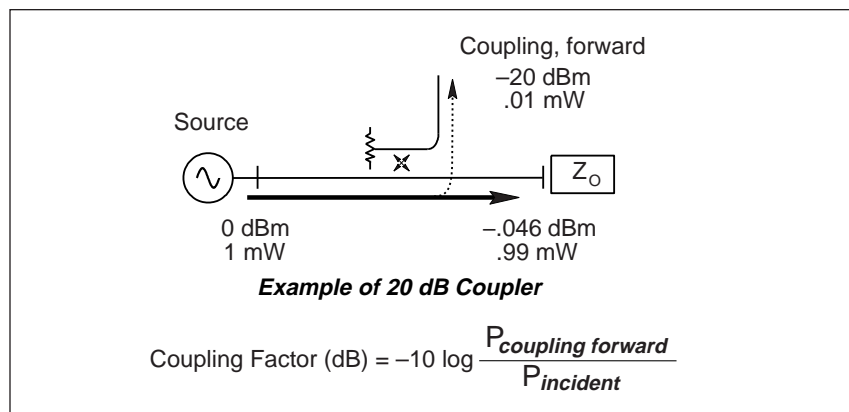

For example, in a 20-dB coupler, the coupled power level is 20 dB less than the power level at the input port. In addition to the coupling factor, a directional coupler has other parameters, such as frequency response and directivity, that contribute to the overall power level seen at both the main output port and the coupled port.

Ideally, a signal traveling in reverse through a coupler should not appear at the coupled port. In reality, some energy always appears at the coupled port because of the coupler's finite port-to-port isolation (Figure 4). Isolation can be measured by sending power through the coupler in the reverse direction, and is defined as the leakage power at the coupled port relative to the incident power:

$$\text{Isolation (in dB)} = -10 \log (\text{reverse coupled power} / \text{incident power})$$

Figure 4.
Directional
Coupler Isolation
(Reverse
Coupling Factor)

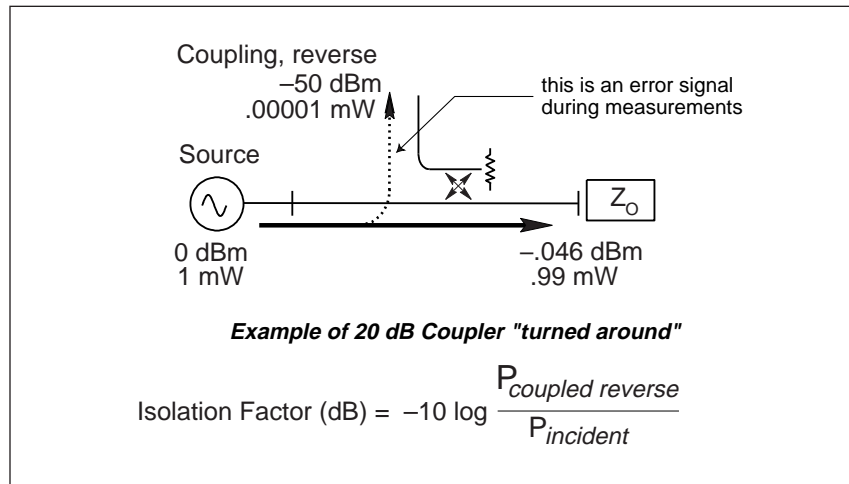

One of the most important measured parameters for couplers is their directivity (Figure 5). Directivity is a measure of a coupler's ability to separate signals flowing in opposite directions along the through path of the coupler. It can be thought of as the dynamic range available for reflection measurements. By definition, directivity is the coupling factor times any loss in the through path, divided by the reverse isolation (all terms are linear). In logarithmic terms, directivity is equal to the reverse coupling factor (isolation) minus the forward coupling factor minus the loss of the through arm (all terms in dB). When measuring forward and reverse coupling factors, the coupler must be terminated in a load impedance that is precisely equal to the characteristic impedance of the test system.

Notice in the middle example of Figure 5 that adding loss (an attenuator for example) at the output of the coupler degrades raw (uncorrected) directivity by twice the value of the attenuator. This is why it is usually not a good idea to place attenuators or use lossy cables on any network analyzer test port that will be used for reflection measurements. Even when calibration is used to correct for the effect of the loss, the stability of the calibration will be worse (i.e., more drift will occur) due to the degraded raw directivity. Attenuation added between the source and the coupler has no effect on directivity, as shown in the lower example. While not shown, it is obvious that adding an attenuator on the coupled port would also not affect directivity since both the isolation and coupling term would be increased by the value of the attenuator.

Errors due to finite directivity are often responsible for ripple patterns in many measurements of return loss. At the peaks of the ripple, directivity adds in-phase with reflections from the DUT. In some cases, directivity will cancel the DUT's reflection, resulting in a sharp dip in the return-loss response.

One simple way to measure coupler directivity doesn't require forward and reverse measurements (Figure 6). This technique is useful for measuring a network analyzer's effective directivity from the front-panel test ports. The first step is to place a short on the test port (the output of the coupler's through arm). Next, measure reflection and normalize the results (by saving data to memory and then displaying data divided by memory). The result is a 0 dB reference that includes the forward coupling factor and the through arm loss. The next step is to place a high-quality termination on the test port (a load from a calibration kit, for example). The signal now measured is only due to the leakage (directivity) error, based on the assumption of a perfect termination. Since the measurement has already been normalized, the measured value is the effective directivity of the coupler or analyzer.

Figure 5.
Directional
Coupler
Directivity

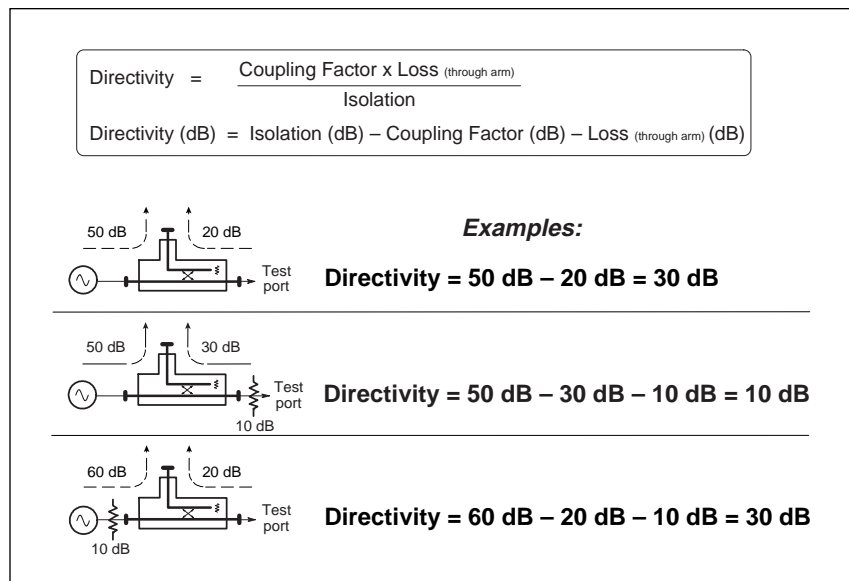
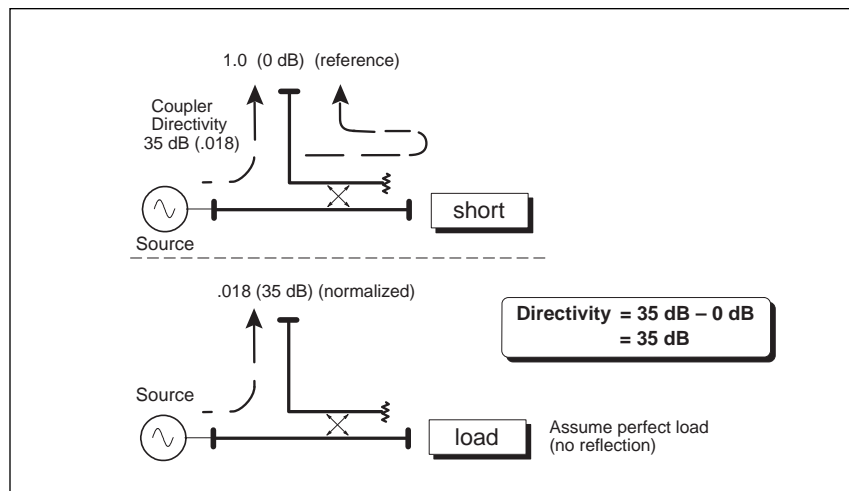

Figure 6.
Measuring
Directivity the
Easy Way



Directional Bridges

Directional bridges can also be used to measure reflected signals. In a directional bridge, if all four arms are equal in resistance, there will be a voltage null (this is the balanced condition). This happens if the test port is terminated with the characteristic impedance of the test system (typically 50 ohms). If the impedance at the test port is not 50 ohms, the voltage across the bridge is proportional to the mismatch presented by the DUT. By measuring both magnitude and phase across such a bridge, it is possible to measure the complex impedance at the test port.

A bridge's equivalent directivity is the ratio (or difference in dB) between maximum balance (measuring a perfect Z_0 load) and minimum balance (measuring a short or open). The effect of bridge directivity on measurement uncertainty is exactly the same as for couplers.

Network Analyzer Detection

Network analyzers, whether scalar or vector, rely on diode (broadband) detection or tuned-receiver (narrowband) techniques. Narrowband detection is suitable for evaluating high-rejection devices such as filters and is necessary when phase measurements are needed. Broadband detection is better suited for characterizing frequency-translation components such as tuners, particularly those with internal local oscillators (LOs).

In a traditional scalar network analyzer, diode detectors convert an RF input signal to a proportional DC level. This method is relatively inexpensive compared to the tuned-receiver approach, but inherently scalar in nature. That is, phase information is not recovered during the detection process. Diode detectors can measure signals to about -60 dBm with a maximum dynamic range of about 75 dB. Since the noise floor is set by the measurement bandwidth, the dynamic range can only be improved by increasing the input test-power level, which may be limited (or expensive to achieve) at higher microwave frequencies. By their nature, broadband diode detectors are useful in measuring frequency-translation devices such as mixers since, ideally, the DC outputs of the diodes are independent of the frequency of the test signals.

The use of AC detection (in which the diode detector extracts the envelope of an amplitude-modulated test signal) can eliminate diode DC drift as a source of measurement error, as well as reduce noise and spurious signals, thereby improving overall measurement accuracy. However, AC detection can adversely affect the measurement of some components such as automatic-gain-controlled (AGC) amplifiers, since the test signal must be modulated. For these components, DC detection is best.

All vector network analyzers and some modern scalar network analyzers such as the HP 8711C and 8713C rely on a tuned-receiver architecture to provide high signal sensitivity and wide dynamic range (100 dB or better). A tuned receiver can provide much better sensitivity and dynamic range compared to diode detection, with enhanced harmonic and spurious signal rejection. In a tuned receiver, high-frequency input signals are translated to lower intermediate frequencies (IFs). Noise signals are also translated in frequency, but most of the noise power falls outside the IF bandwidth. By filtering around a narrow band of IF signals, noise can be reduced, resulting in improved sensitivity and dynamic range. The IF bandwidth of tuned receivers may only be 3 kHz (and often much narrower), compared to a measurement bandwidth as wide as 40 GHz in a diode-detector-based scalar network analyzer.

Tuned receivers also allow improved techniques for error correction since phase information is preserved in the detection process. This allows scalar network analyzers such as the HP 8711C and 8713C to offer forms of vector error correction (normally only found on vector network analyzers) to enhance measurement accuracy.

The dynamic range of a tuned receiver can be improved by boosting input power, decreasing IF bandwidth, or by averaging the test signals. The latter two techniques provide a trade off between noise floor and measurement speed. Averaging reduces the noise floor of the network analyzer (as opposed to just reducing the noise excursions as happens when averaging spectrum analyzer data) because the network analyzer averages complex data. Without phase information, averaging does not improve analyzer sensitivity.

Tuned receivers can be implemented with either high-frequency mixers or samplers. It is often simpler and less expensive to make wideband front ends using samplers instead of mixers, especially for microwave frequency coverage. In Hewlett-Packard vector network analyzers such as the HP 8753D and HP 8720D, sampling is the chosen technique. Diode-based samplers can be thought of as mixers with internal pulse generators.

The pulse generator creates a broadband frequency spectrum or comb comprised of harmonically-related signals from the analyzer's LO. The incoming RF signal is mixed with the appropriate comb signal to produce the desired IF signal. Unfortunately, all of the comb signals contribute to downconverted noise in the IF, making the noise figure of the sampler approach somewhat worse than when mixer-based tuned receivers are used. However, sampler-based analyzers still provide far greater dynamic range than analyzers based on broadband diode detectors.

Comparing Dynamic Range

Wide dynamic range can be critical for measurements on some components, such as switches and high-dynamic-range filters. A filter with 90 dB out-of-band rejection would need far greater dynamic range than that available from a scalar network analyzer that only offered diode detection. When a typical narrowband filter is evaluated with an HP 8757 diode-detector-based scalar network analyzer and an HP 8720 vector network analyzer, the wide dynamic range of the latter reveals the filter's true out-of-band response (Figure 7).

In fact, the broadband, diode-detection-based response of the scalar network analyzer shows a false signal below the filter passband, created by a harmonic of the test signal. When a harmonic of the test tone falls within the passband of the filter (for example, when the source frequency is one-half the frequency of the filter passband), the analyzer will register a response even though the filter's stopband is severely attenuating the fundamental test tone. Such a spurious response is effectively filtered by the narrow IF passband of the tuned receiver.

Noise that limits dynamic range can also affect measurement accuracy. To minimize measurement uncertainties, the dynamic range of the measurement system should exceed that of the DUT. For example, to achieve less than 0.1 dB magnitude error and less than 0.6 degree phase error, the noise floor must be more than 40 dB below the measured power level (Figure 8). To achieve that level of accuracy while measuring 70 dB of rejection would require 110 dB of dynamic range. This could be accomplished by averaging test data with a tuned-receiver-based network analyzer.

Figure 7.
Comparison of
Receiver
Techniques

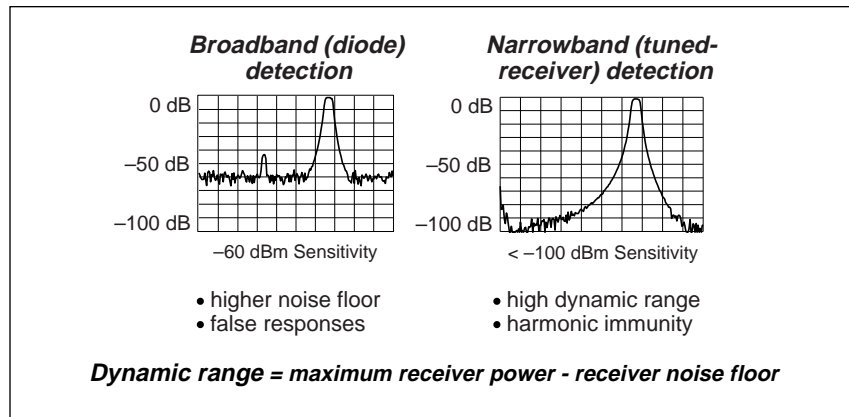
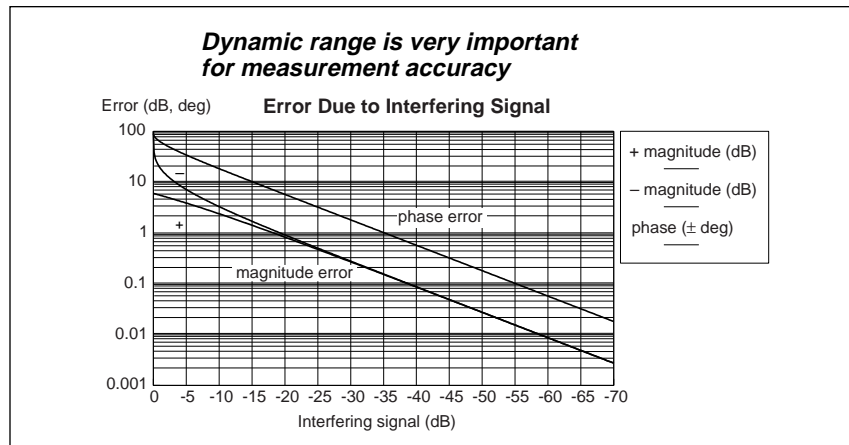

Figure 8.
Dynamic Range
and Accuracy



The Spectrum Analyzer Alternative

A spectrum analyzer with a dedicated tracking generator and an external coupler or directional bridge can approximate the operation of a scalar network analyzer by showing amplitude as a function of swept frequency. However, the spectrum analyzer cannot make ratioed measurements or phase measurements. It is also limited to simple normalization in terms of error correction, providing far less measurement accuracy (see *Applying Error Correction to Network Analyzer Measurements*, Hewlett-Packard Application Note 1287-3). The amplitude accuracy of a spectrum analyzer is about an order of magnitude less than that of a scalar network analyzer. In addition, a spectrum analyzer and tracking generator generally cost more than a scalar network analyzer. This added cost may not make sense unless the spectrum analyzer is required for other measurements or applications.

The Test Set

Network analyzers work with different types of test sets, including transmission/reflection (T/R) test sets and S-parameter test sets (Figure 9). T/R test sets provide test signals for the input of the DUT from port 1 and connection of the DUT's output port to the network analyzer's receiver via port 2. To measure reverse transmission or output reflection of the DUT, it must be disconnected, turned around, and re-connected to the analyzer. Because of the inherent inability to provide power at port 2, T/R-based network analyzers are limited to response and one-port calibration techniques.

The more sophisticated S-parameter test set provides both forward and reverse measurements of a DUT. The RF power is available from either port 1 or port 2, and either test port can be connected to the vector network analyzer's receiver inputs. Such test sets allow the use of full two-port error correction techniques for the highest measurement accuracy.

S-parameter test sets are available with either three or four receivers. The three-receiver architecture is simpler and therefore less expensive, but the four-receiver architecture offers more advanced error correction (including TRL and LRM calibration). A three-receiver S-parameter test set can only perform modified through-reflect-line (TRL*) and modified line-reflect-match (LRM*) calibrations. The more flexible calibration capabilities of four-receiver test sets make them more suitable for noncoaxial applications such as on-wafer measurements (see *Applying Error Correction to Network Analyzer Measurements*, Hewlett-Packard Application Note 1287-3).

Figure 9.
T/R versus
S-Parameter Test
Sets

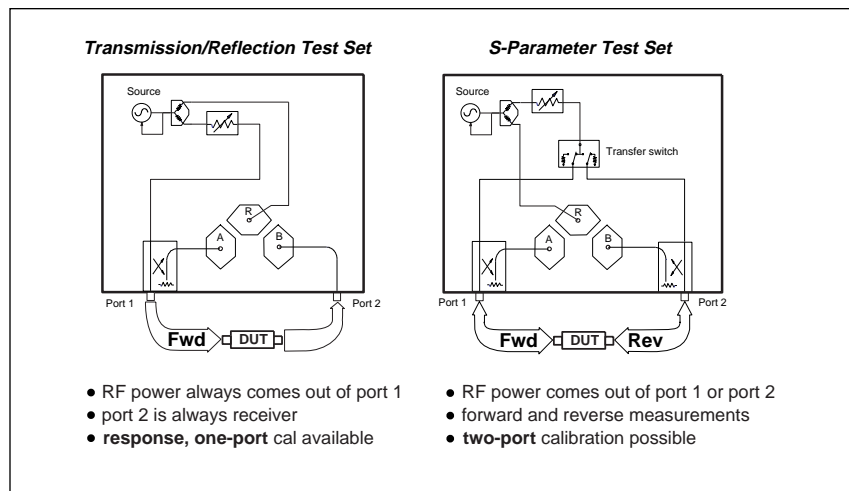

Other Considerations

In selecting a network analyzer for device testing, measurement precision and accuracy are critical, but other factors are also important. A flexible display screen can simplify tasks such as filter tuning. The screen should also be aided by generous marker capabilities in order to define such characteristics as filter 3-dB bandwidth during repetitive, production testing. Another important feature for manufacturing is limit-line capability, which greatly simplifies pass/fail testing.

Since many network analyzers are also used as part of an automatic-test-equipment (ATE) installation, the computing power and interface capabilities of the analyzer are often important. Many network analyzers have an onboard microcomputer that can control external instruments such as swept-signal sources for mixer testing, or power meters for enhanced calibration capabilities. In addition, most of HP's analyzers offer 3.5-in. floppy disk drives to simplify the task of upgrading internal software or downloading test data for further analysis on an external computer or use in a CAE program.

A network analyzer's internal computing power can also be used to automate measurements even when the analyzer is used in a "stand-alone" application. For example, the use of test sequencing in the HP 8720 and HP 8753 vector network analyzers makes it simple to store a series of keystrokes on the analyzer as a measurement routine. Several of these routines can be readily saved in the analyzer's memory to create a small automated test station even without an external computer. Such capabilities are ideal for repetitive testing as performed in a production environment. The HP 8711C family offers even more automation capability with the use of Instrument BASIC (IBASIC).

Suggested Reading

Understanding the Fundamental Principles of Vector Network Analysis, Hewlett-Packard Application Note 1287-1.

Applying Error Correction to Network Analyzer Measurements, Hewlett-Packard Application Note 1287-3.

Network Analyzer Measurements: Filter and Amplifier Examples, Hewlett-Packard Application Note 1287-4.

For more information about Hewlett-Packard test and measurement products, applications, services, and for a current sales office listing, visit our web site, <http://www.hp.com/go/tmdir>. You can also contact one of the following centers and ask for a test and measurement sales representative.

United States:

Hewlett-Packard Company
Test and Measurement Call Center
P.O. Box 4026
Englewood, CO 80155-4026
1 800 452 4844

Canada:

Hewlett-Packard Canada Ltd.
5150 Spectrum Way
Mississauga, Ontario
L4W 5G1
(905) 206 4725

Europe:

Hewlett-Packard
European Marketing Centre
P.O. Box 999
1180 AZ Amstelveen
The Netherlands
(31 20) 547 9900

Japan:

Hewlett-Packard Japan Ltd.
Measurement Assistance Center
9-1, Takakura-Cho, Hachioji-Shi,
Tokyo 192, Japan
Tel: (81-426) 56-7832
Fax: (81-426) 56-7840

Latin America:

Hewlett-Packard
Latin American Region Headquarters
5200 Blue Lagoon Drive, 9th Floor
Miami, Florida 33126, U.S.A.
(305) 267 4245/4220

Australia/New Zealand:

Hewlett-Packard Australia Ltd.
31-41 Joseph Street
Blackburn, Victoria 3130, Australia
1 800 629 485

Asia Pacific:

Hewlett-Packard Asia Pacific Ltd.
17-21/F Shell Tower, Times Square,
1 Matheson Street, Causeway Bay,
Hong Kong
Tel: (852) 2599 7777
Fax: (852) 2506 9285